

CS 6530: Advanced Database Systems Fall 2023

Lecture 12

Row Stores vs Column Stores

Prashant Pandey

prashant.pandey@utah.edu

Acknowledgement: Slides taken from Prof. Manos Athanassoulis, Boston University

Row-stores vs. Col-Stores: How Different Are They Really?

Are column-stores really novel?

If we profile their performance, what is the breakdown? Why?

Row-Stores

Student (sid: string, name: string, login: string, year_birth: integer, gpa: real)

student

(sid1, name1, login1, year1, gpa1)
(sid2, name2, login2, year2, gpa2)
(sid3, name3, login3, year3, gpa3)
(sid4, name4, login4, year4, gpa4)
(sid5, name5, login5, year5, gpa5)
(sid6, name6, login6, year6, gpa6)
(sid7, name7, login7, year7, gpa7)
(sid8, name8, login8, year8, gpa8)
(sid9, name9, login9, year9, gpa9)

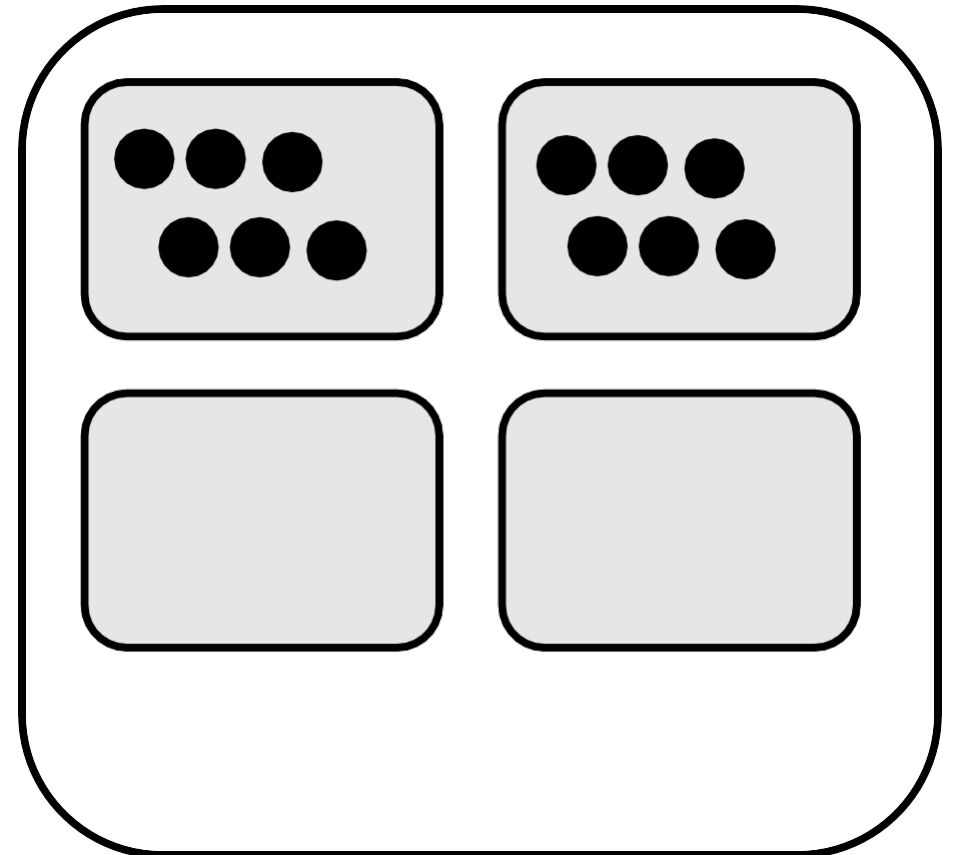

Row-Stores: slotted page

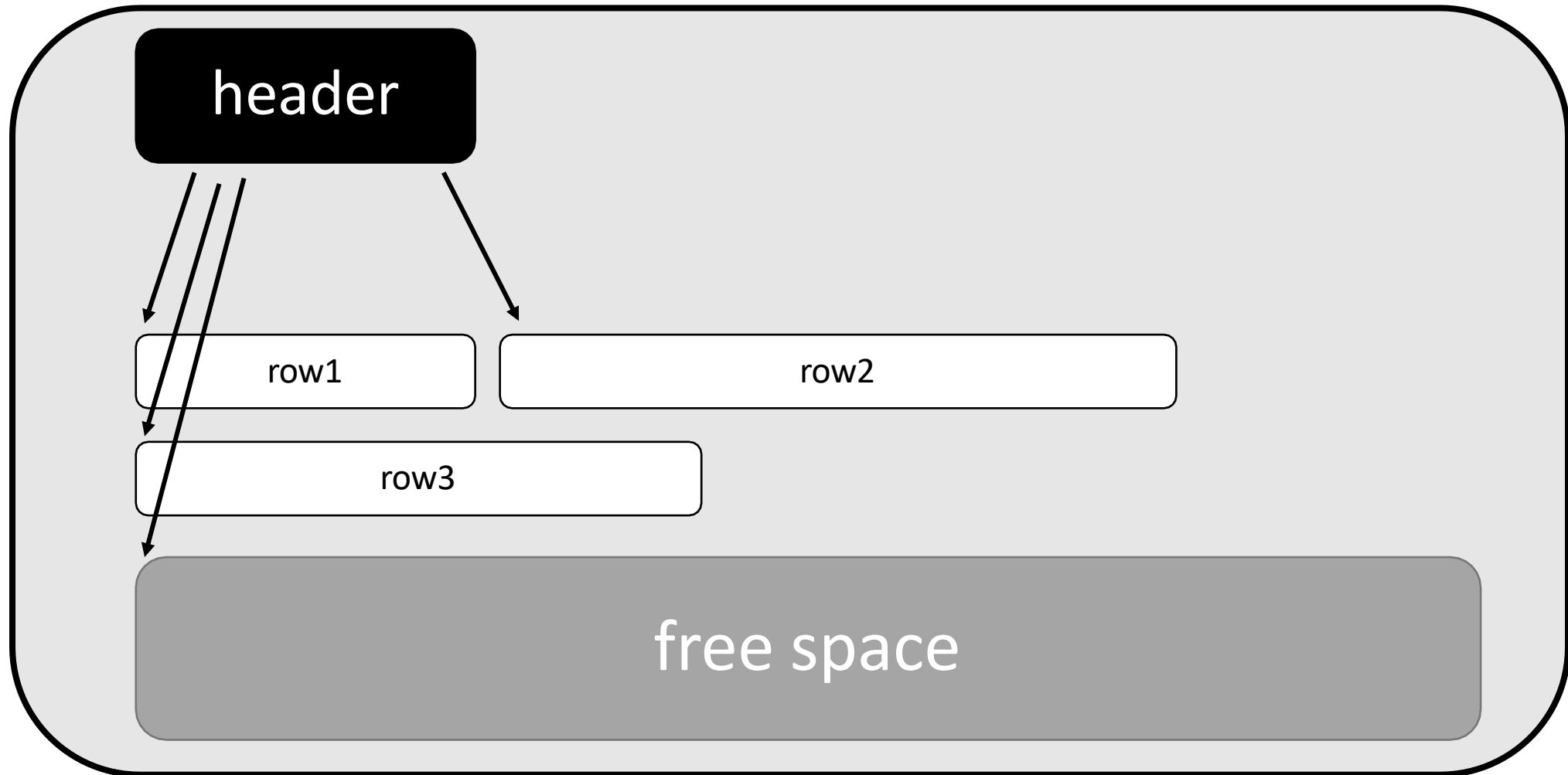

Row-Stores: slotted page

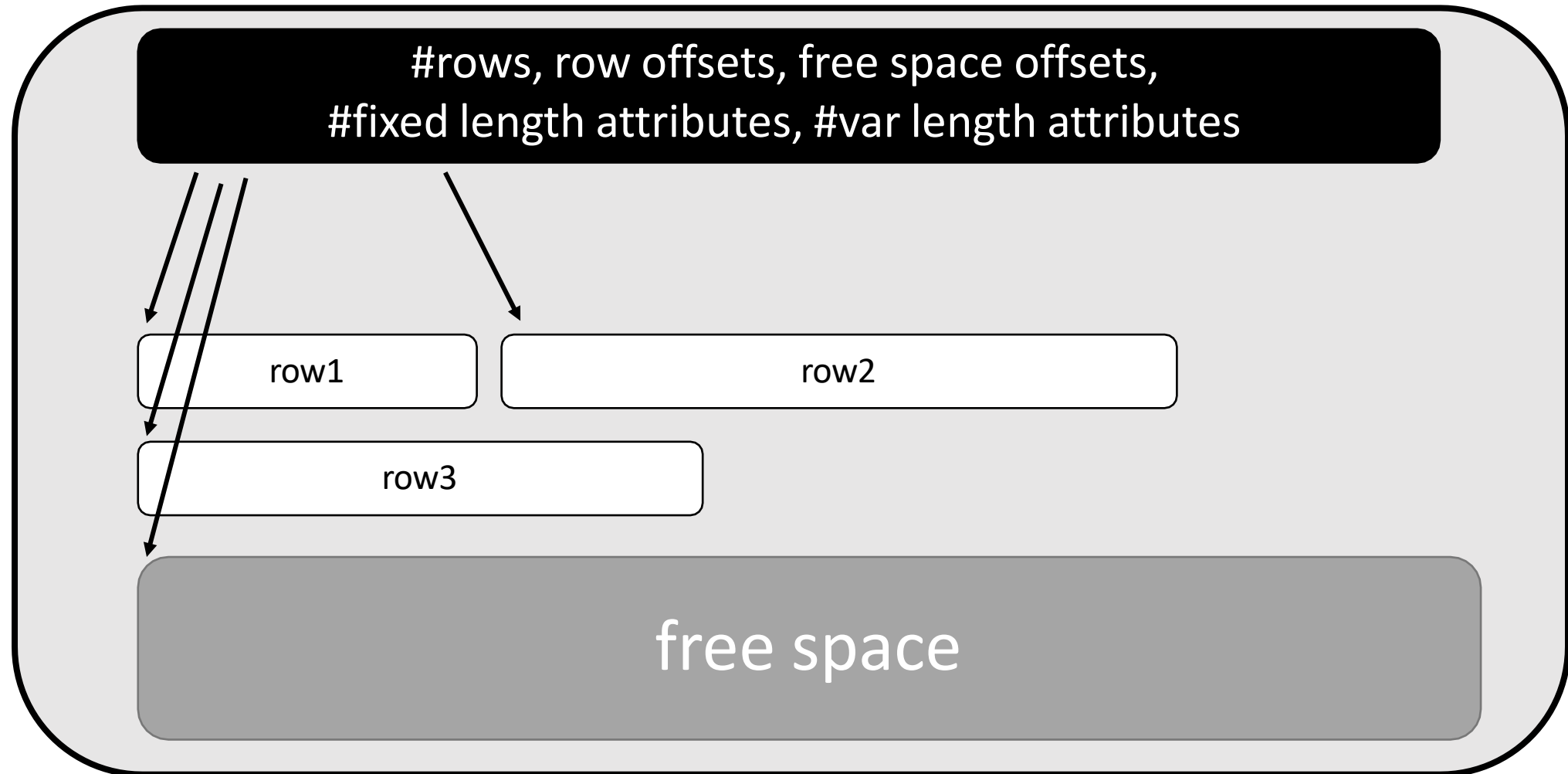

Row-Stores



pros and cons?

file

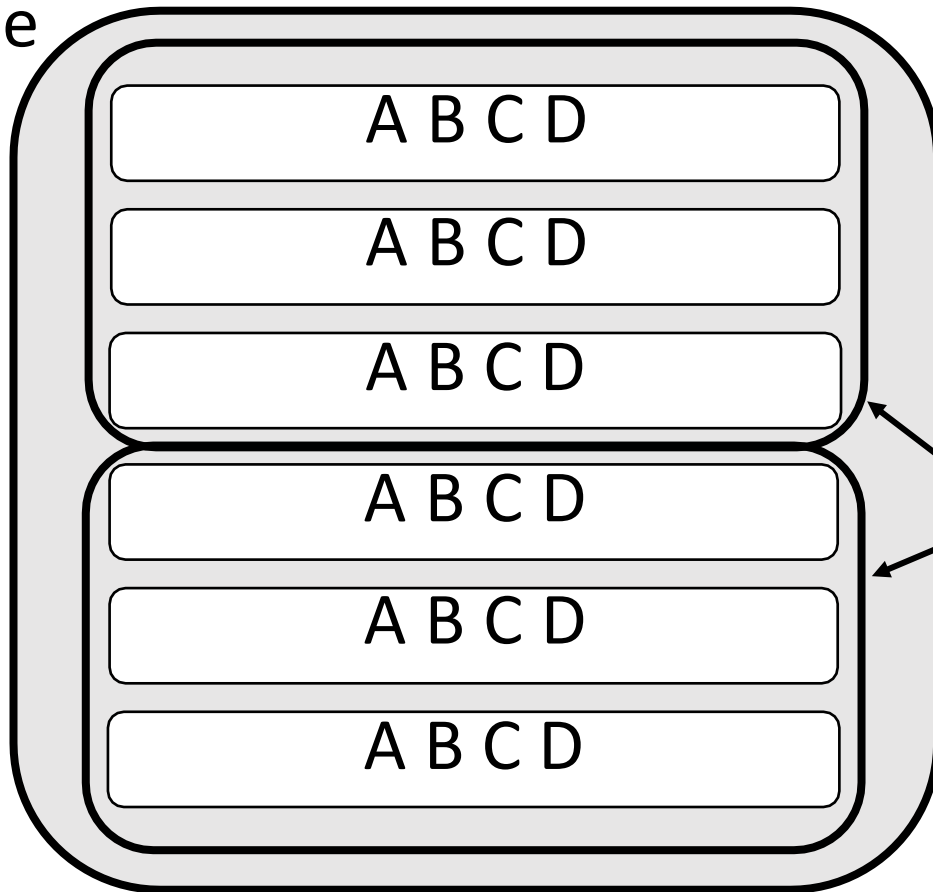

each page contains **entire** rows (all their columns)

pages

rows are **contiguous**

(with possible free space at the end)



Easy to add a new record



Might access unnecessary data

Row-stores: query processing

select max(B) from R where A>5 and C<10

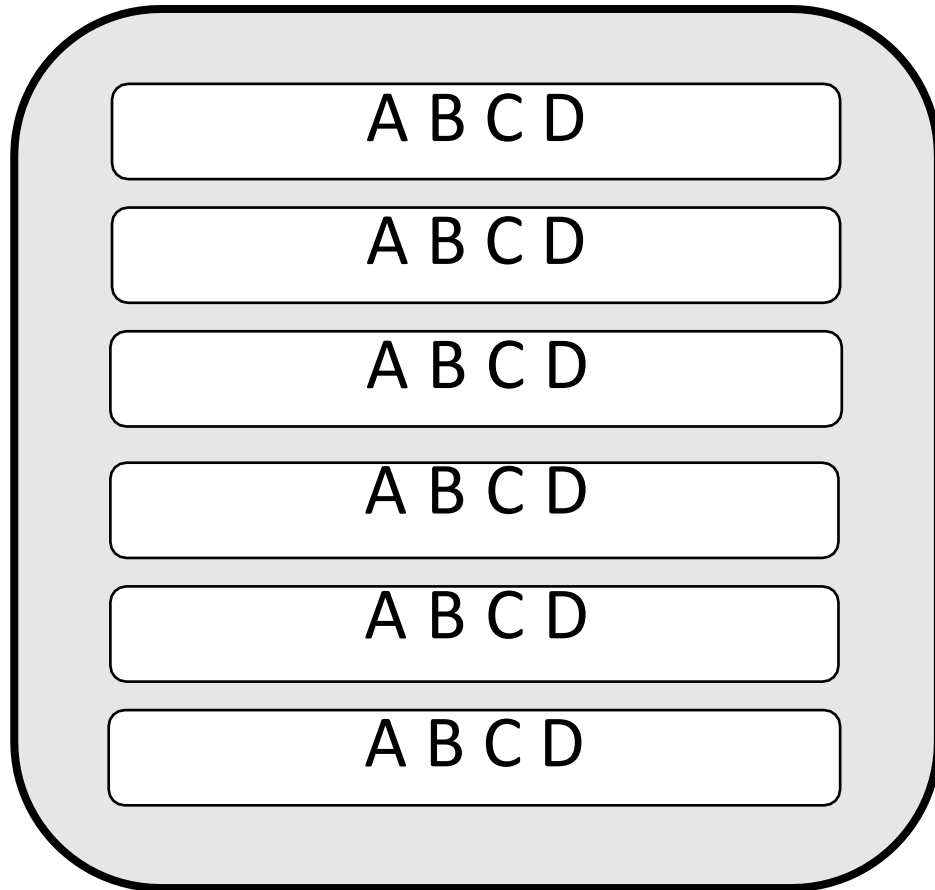

one row at a time

Column-Stores

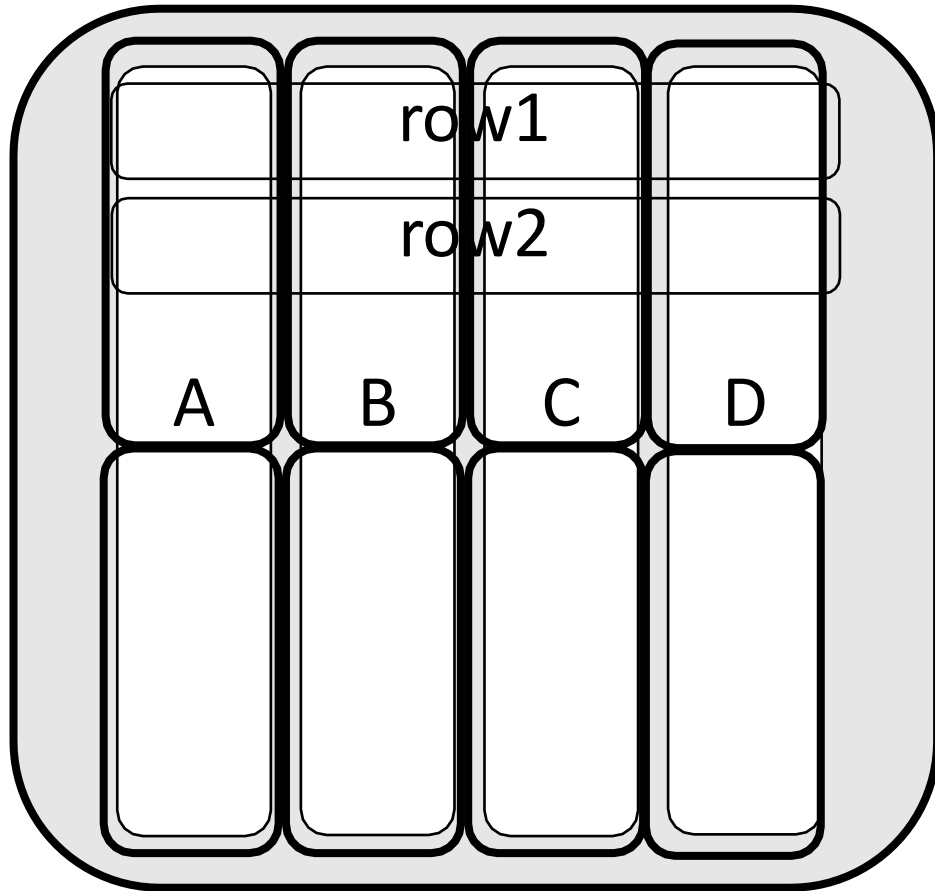

pros and cons?

✓ Read only relevant data

✗ Tuple writes require multiple accesses

each page contains **columns!**

Column-stores: query processing

select max(B) from R where A>5 and C<10

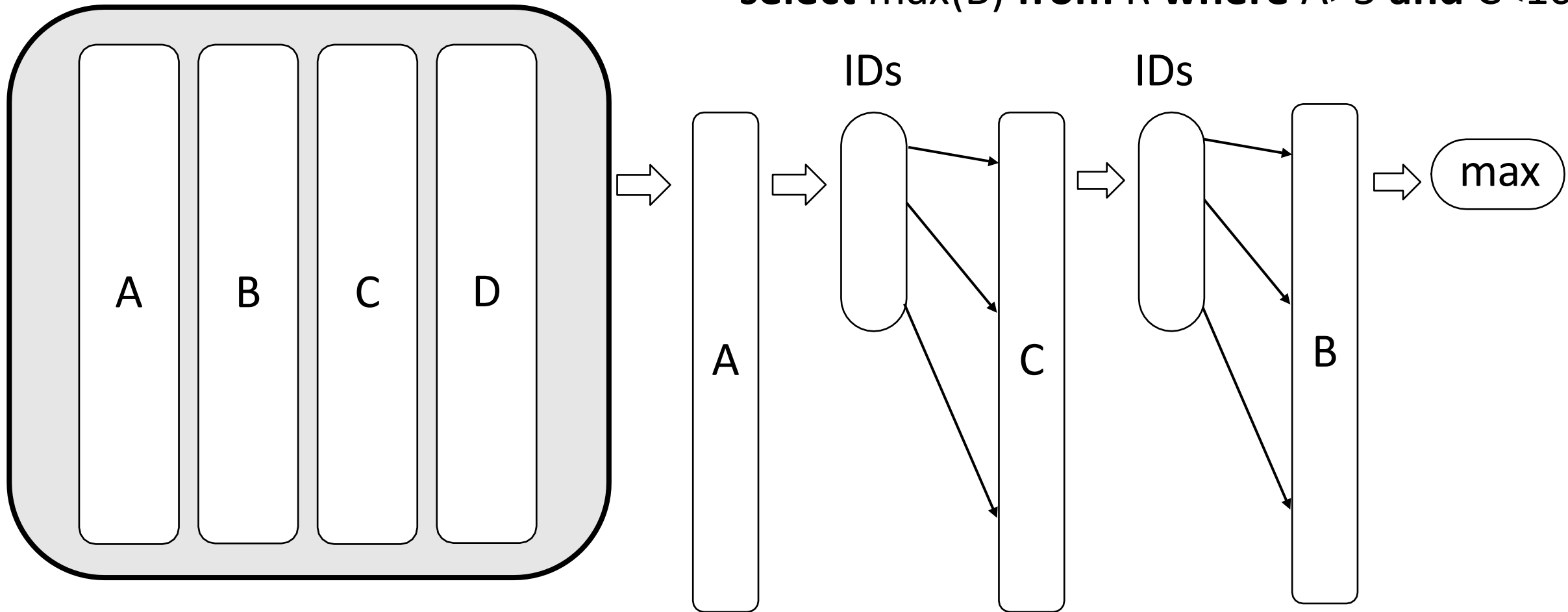

Let's revisit the main question

There several studies showing

column-stores outperforming row-stores (~5x better performance in TPCH)

especially for

read-mostly data warehouses that have

1. column scans and aggregations
2. few and batched writes

Key question:

(a) are the benefits **inherent to the new column-store design**, or

(b) a **row-store with a “more columnar”** physical design can **achieve the same?**

In other words: ***can you “simulate a col-store in a row-store?”***

State-of-the-art Col-Store features

Late Materialization

“stich the column together as late as possible”

Block iteration

“execute the same columnar operation over a block of values”

Compression

“column-specific compression, due to the nature of data”

Late Materialization

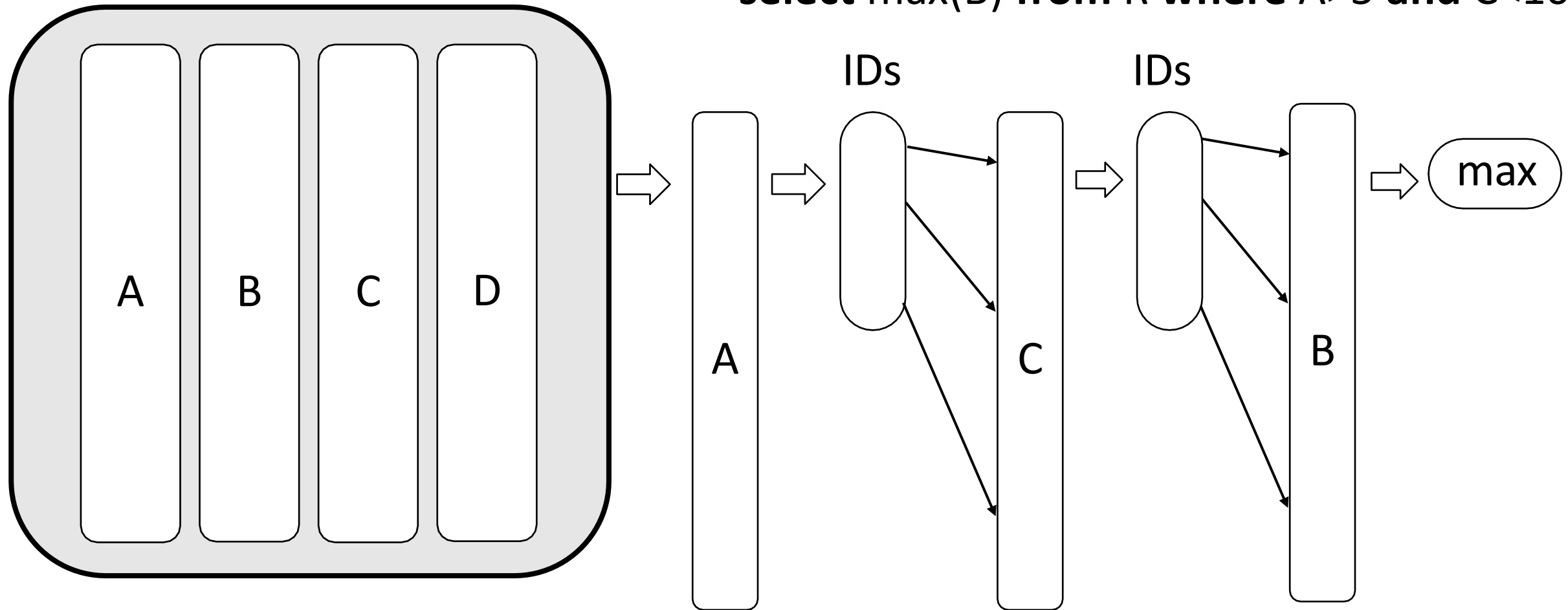

“the full tuple (or the necessary subset) is not materialized until it is needed”

“Column-at-a-time”

select max(B) from R where A>5 and C<10

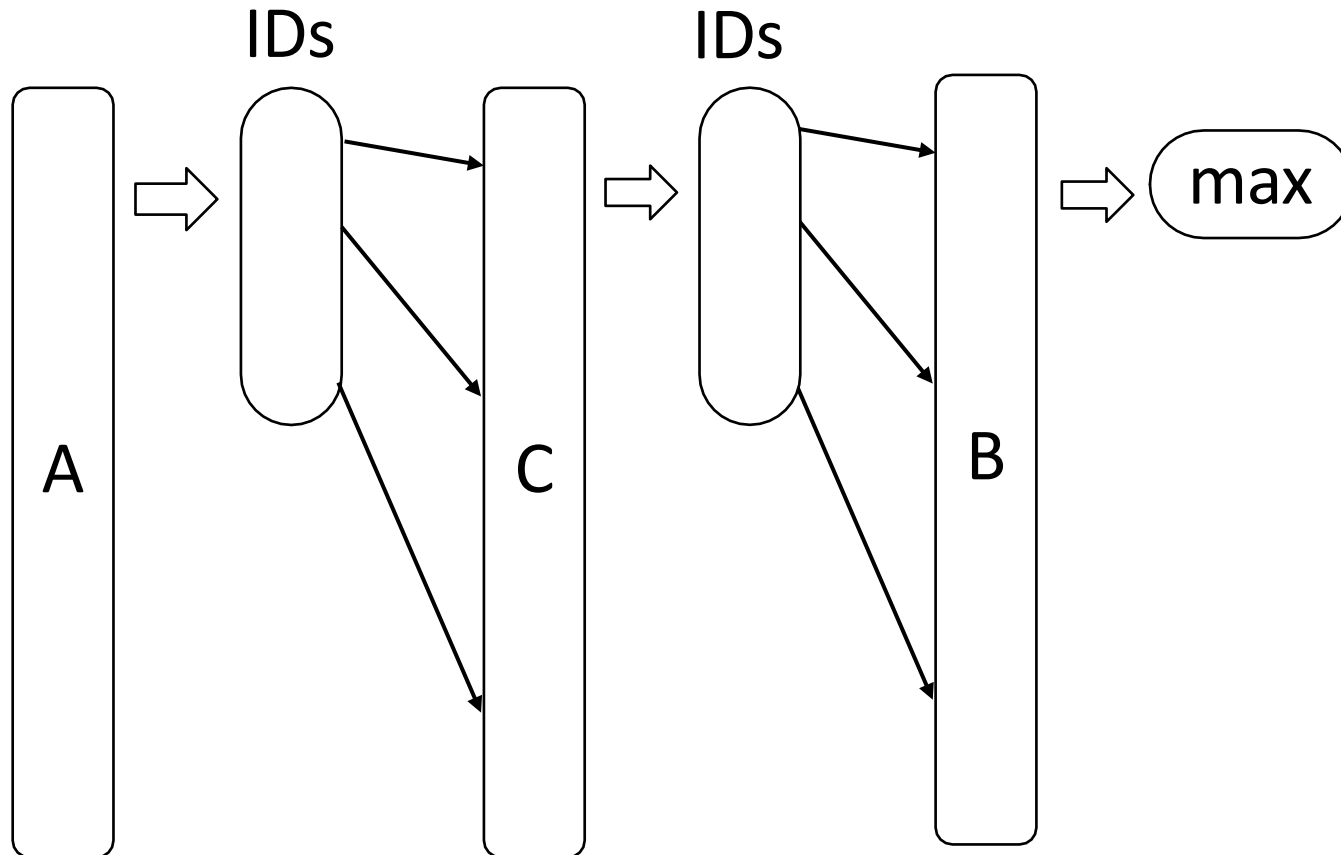

whole column?

column at a time

block/vector at a time

Block Iteration

select max(B) from R where A>5 and C<10

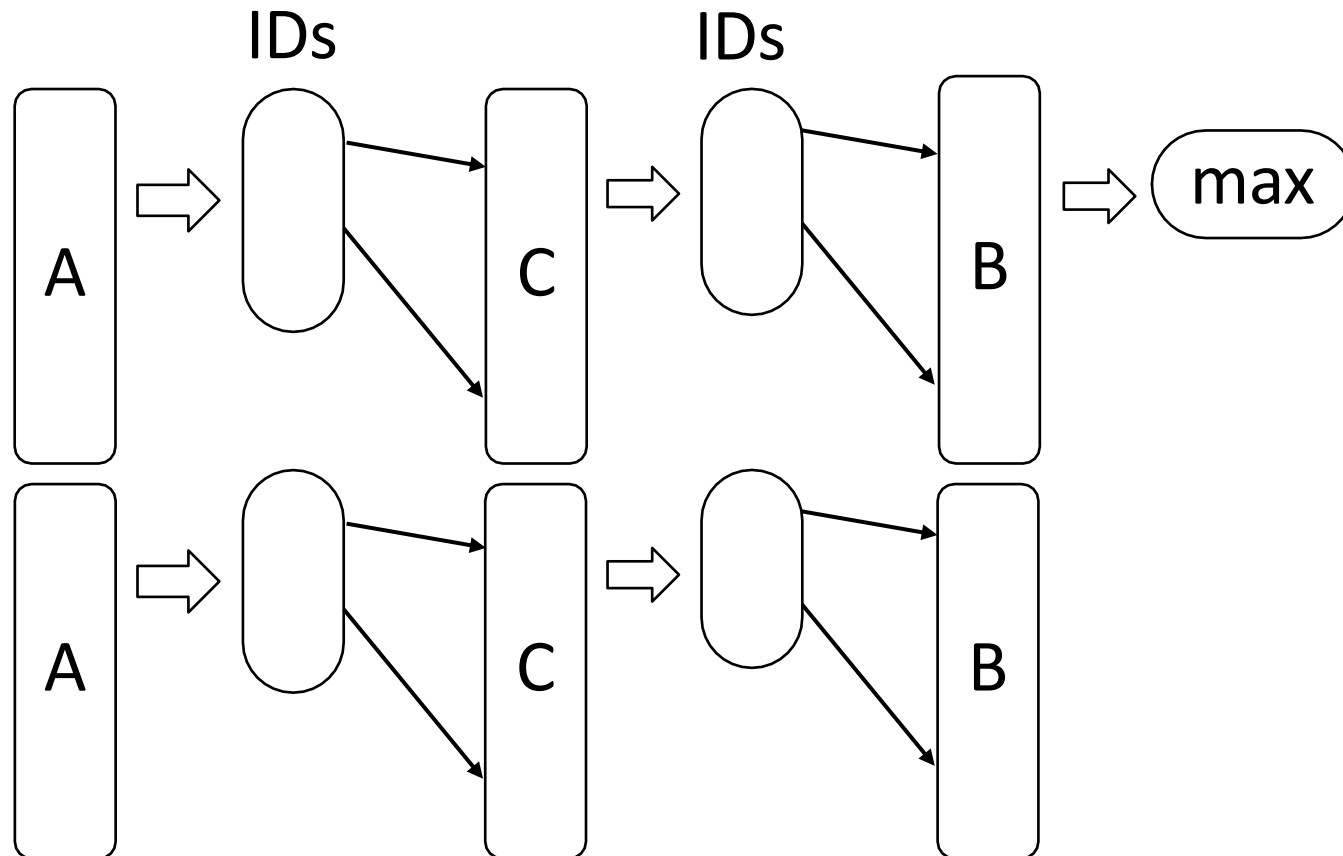

whole column?

column at a time

block/vector at a time

What is easier to compress?



#1, John, 2/4/88, Boston

#2, Joe, 2/1/87, New York

#3, Lina, 7/7/93, Boston

#4, Anna, 4/1/92, Chicago

#5, Tim, 3/9/91, Seattle

#6, Rose, 9/3/96, Boston

#1	John	2/4/88	Boston
#2	Joe	2/1/87	New York
#3	Lina	7/7/93	Boston
#4	Anna	4/1/92	Chicago
#5	Tim	3/9/91	Seattle
#6	Rose	9/3/96	Boston

exploit patterns, duplicates, small differences

How to simulate a col-store with a row-store?

Vertical Partitioning

“physically partition the data per column”

Index-only Plans

“use only indexes in query plans that contain only relevant columns”

Materialized Views

“temporary tables that contain exactly the answer to a query”

Vertical Partitioning

select max(B) from R where A>5 and C<10

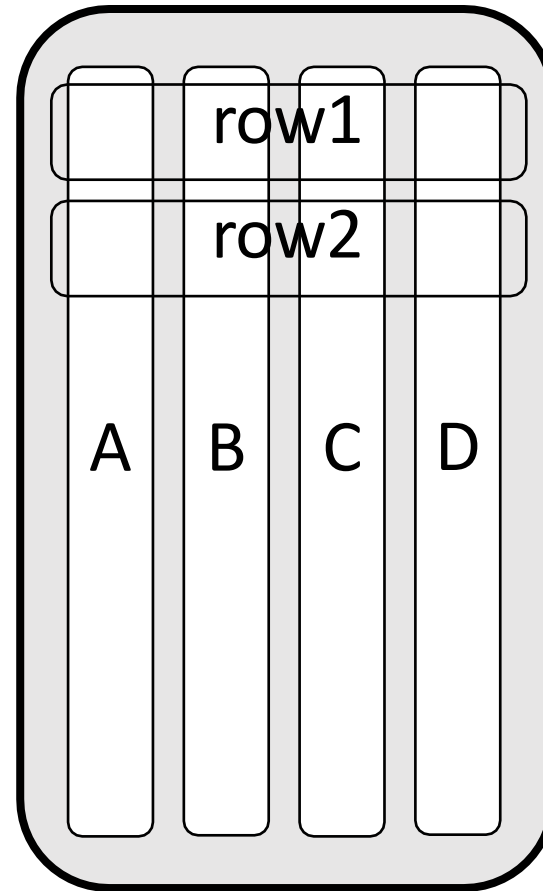
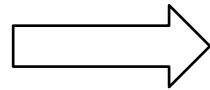
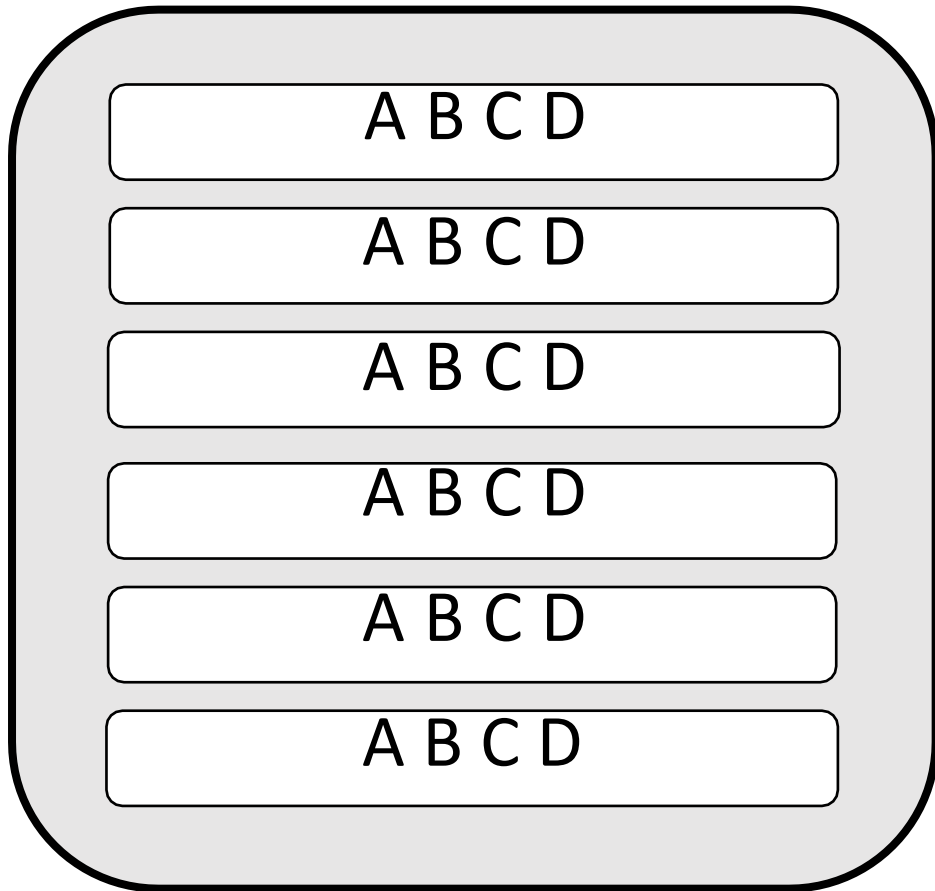

select max(B) from R where A>5 and C<10

Index-only plans

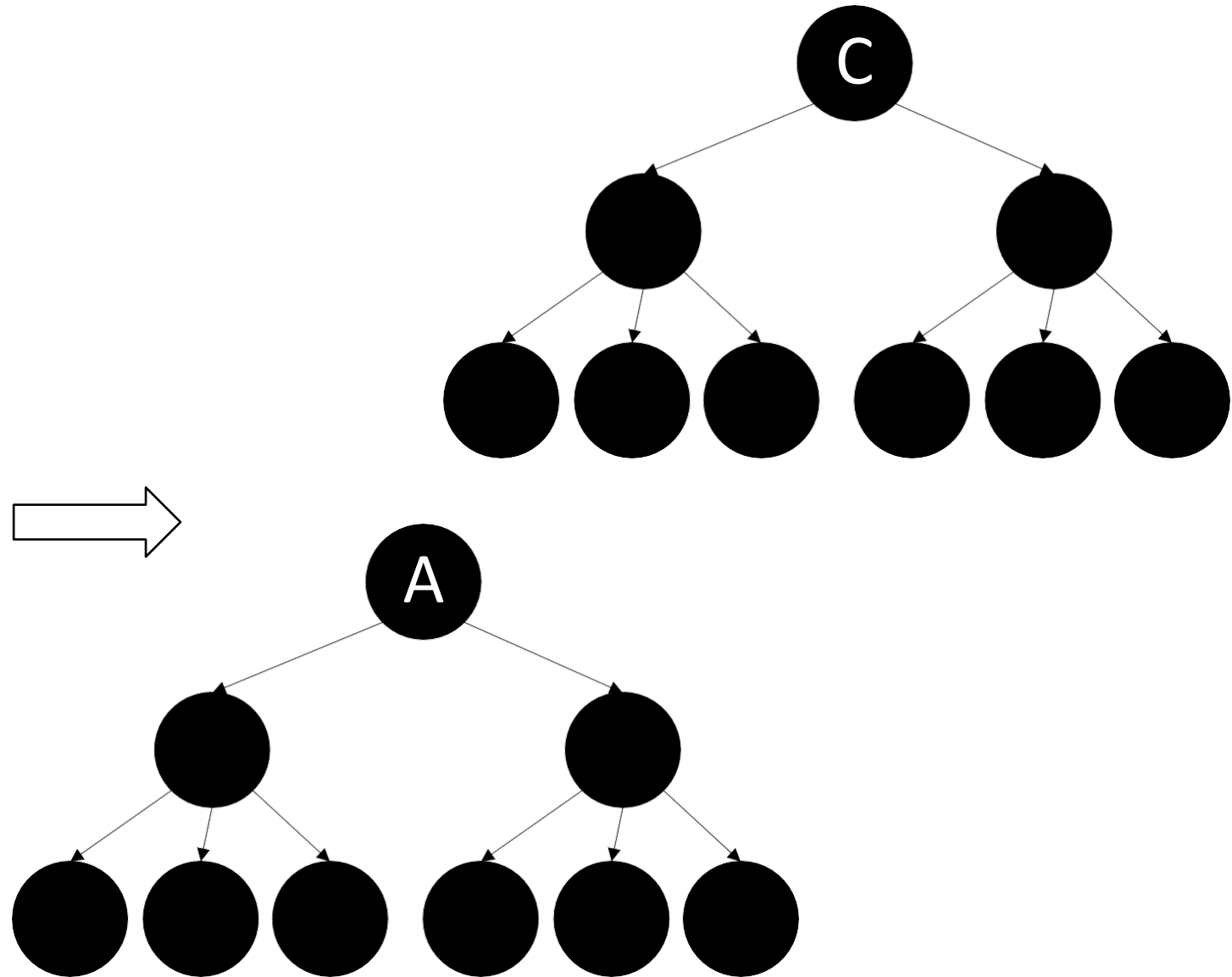
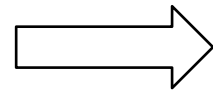
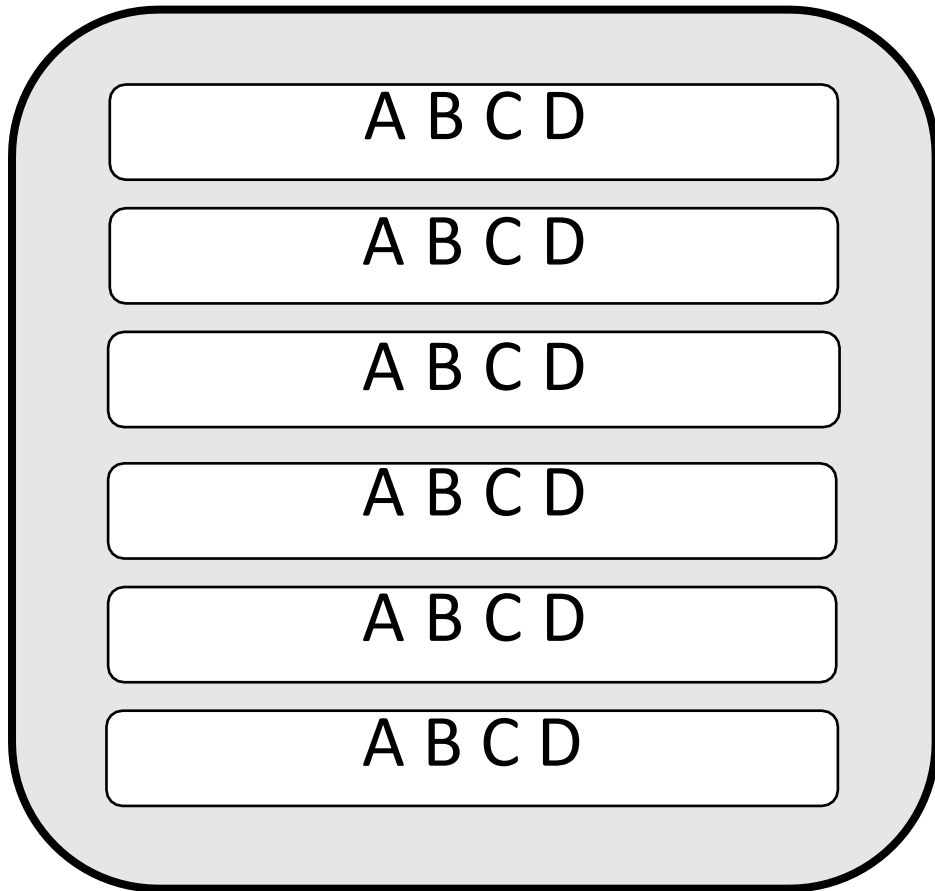

Materialized Views

select B, C from R where A>5 and C<10

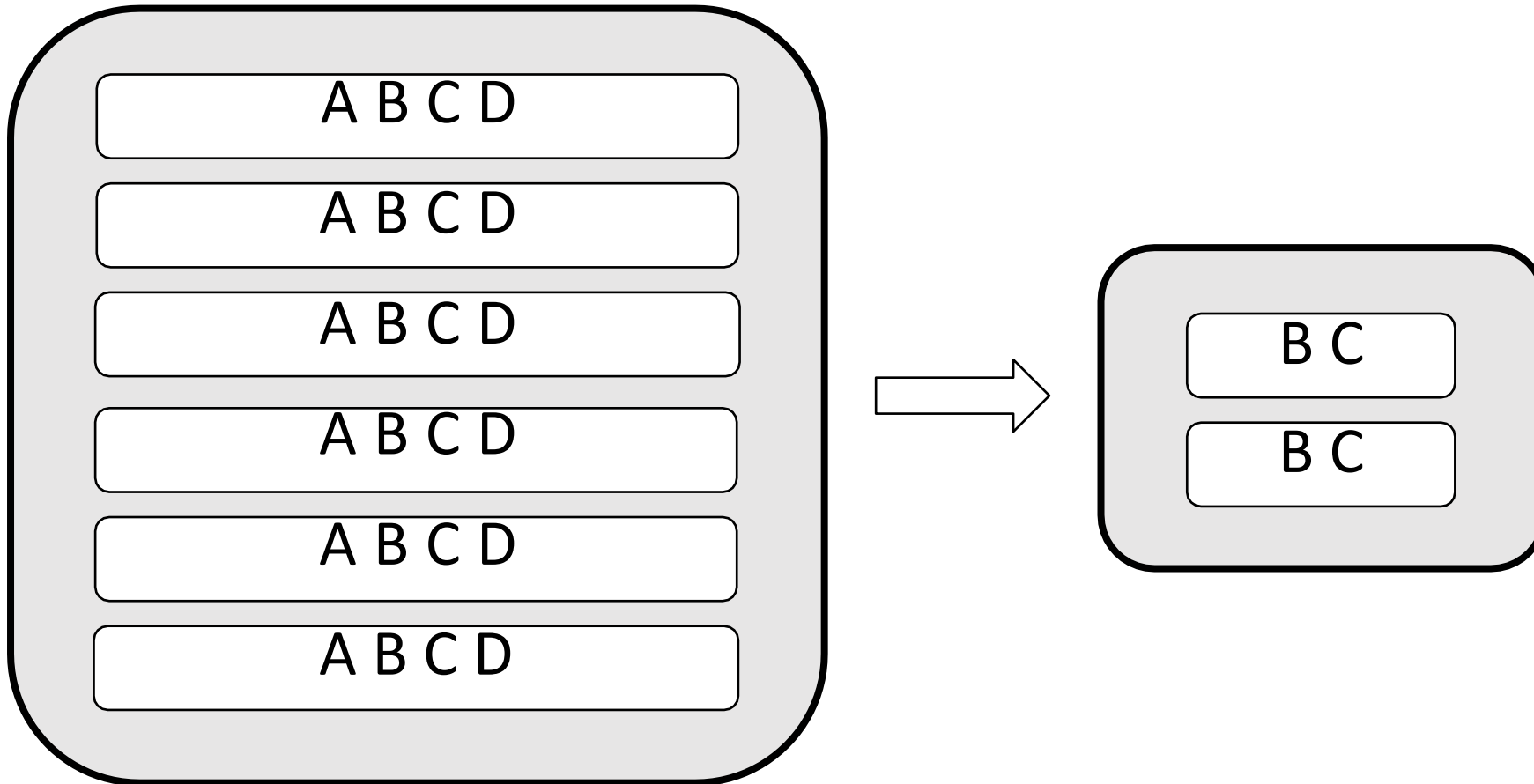

Benchmarking

When comparing database systems we need a common “language”

Benchmarks from the ***Transaction Performance Council***

TPC-B, TPC-C, TPC-H, TPC-DS etc

Also, a benchmark for data warehousing:

Star Schema Benchmark

Star-Schema Benchmark

13 queries

```

select sum(lo_extendedprice*lo_discount) as revenue
from lineorder, date
where lo_orderdate = d_datekey and
        d_year = 1993 and
        lo_discount between 1 and 3 and
        lo_quantity < 25;
    
```

```

select sum(lo_revenue), d_year, p_brand1
from lineorder, date, part, supplier
where lo_orderdate = d_datekey and
        lo_partkey = p_partkey and
        lo_suppkey = s_suppkey and
        p_category = 'MFGR#12' and
        s_region = 'AMERICA'
group by d_year, p_brand1
order by d_year, p_brand1;
    
```

Fact table

CUSTOMER
CUSTKEY
NAME
ADDRESS
CITY
NATION
REGION
PHONE
MKTSEGMENT

Size=scalefactor x 30,000

SUPPLIER
SUPPKEY
NAME
ADDRESS
CITY
NATION
REGION
PHONE

Size=scalefactor x 2,000

LINEORDER
ORDERKEY
LINENUMBER
CUSTKEY
PARTKEY
SUPPKEY
ORDERDATE
ORDPRIORITY
SHIPPRIORITY
QUANTITY
EXTENDEDPRICE
ORDTOTALPRICE
DISCOUNT
REVENUE
SUPPLYCOST
TAX
COMMITDATE
SHIPMODE

Size=scalefactor x 6,000,000

PART
PARTKEY
NAME
MFGR
CATEGORY
BRAND1
COLOR
TYPE
SIZE
CONTAINER

Size=200,000 x (1 + log₂ scalefactor)

DATE
DATEKEY
DATE
DAYOFWEEK
MONTH
YEAR
YEARMONTHNUM
YEARMONTH
DAYNUMWEEK
.... (9 add'l attributes)

Size= 365 x 7

Dimension tables

Experiments

1 CPU 2.8GHz, 3GB RAM, Red Hat Linux 5

4-disk HDD array with 160-200MB/s aggregate bandwidth

(older paper, so small numbers!)

Report averages with “warm” bufferpool (smaller than data size)

Focus on SSB averages (the paper has more detailed graphs)

Experimenting with row-stores (SSB averages)

tuple overheads (additional record IDs)

+ could not horizontally partition + more expensive hash joins

```
select sum(lo_revenue), d_year, p_brand1
from lineorder, date, part, supplier
where lo_orderdate = d_datekey and
       lo_partkey = p_partkey and
       lo_suppkey = s_suppkey and
       p_category = 'MFGR#12' and
       s_region = 'AMERICA'
group by d_year, p_brand1
order by d_year, p_brand1;
```

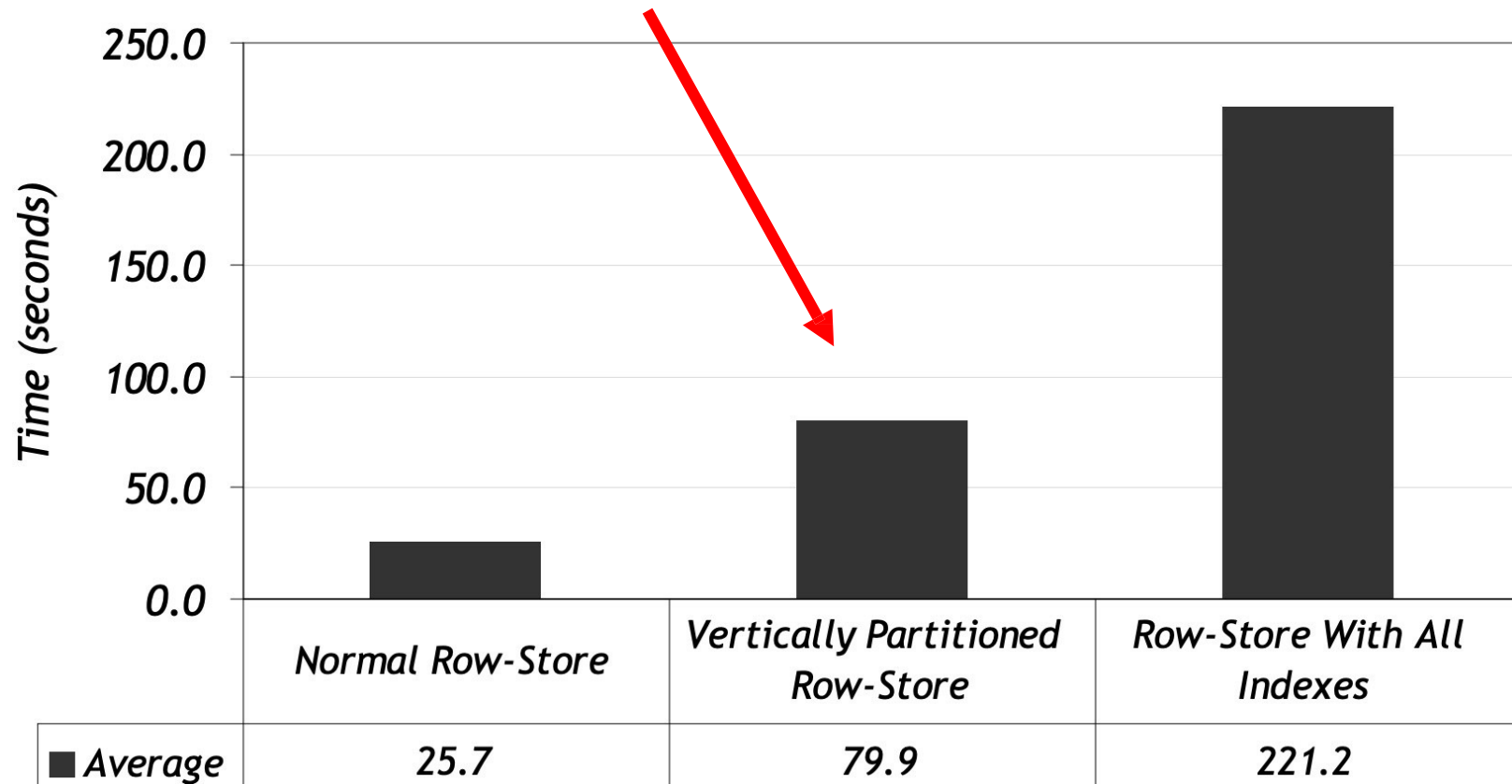

Details on Vertical Partitioning

TID	Column Data
1	
2	
3	

TID	Column Data
1	
2	
3	

Tuple Header	TID	Column Data
	1	
	2	
	3	

Complete fact table 4GB (compressed)

Vertical partitioned tables are 0.7-1.1GB per column (compressed)

*Note that a "real column-store" would only store the raw values as an array.
In this example it would be only 240MB.*

Vertical Partitioning Interferes With Horizontal Partitioning

The fact table is horizontally partitioned (on date, allows to skip lots of data)

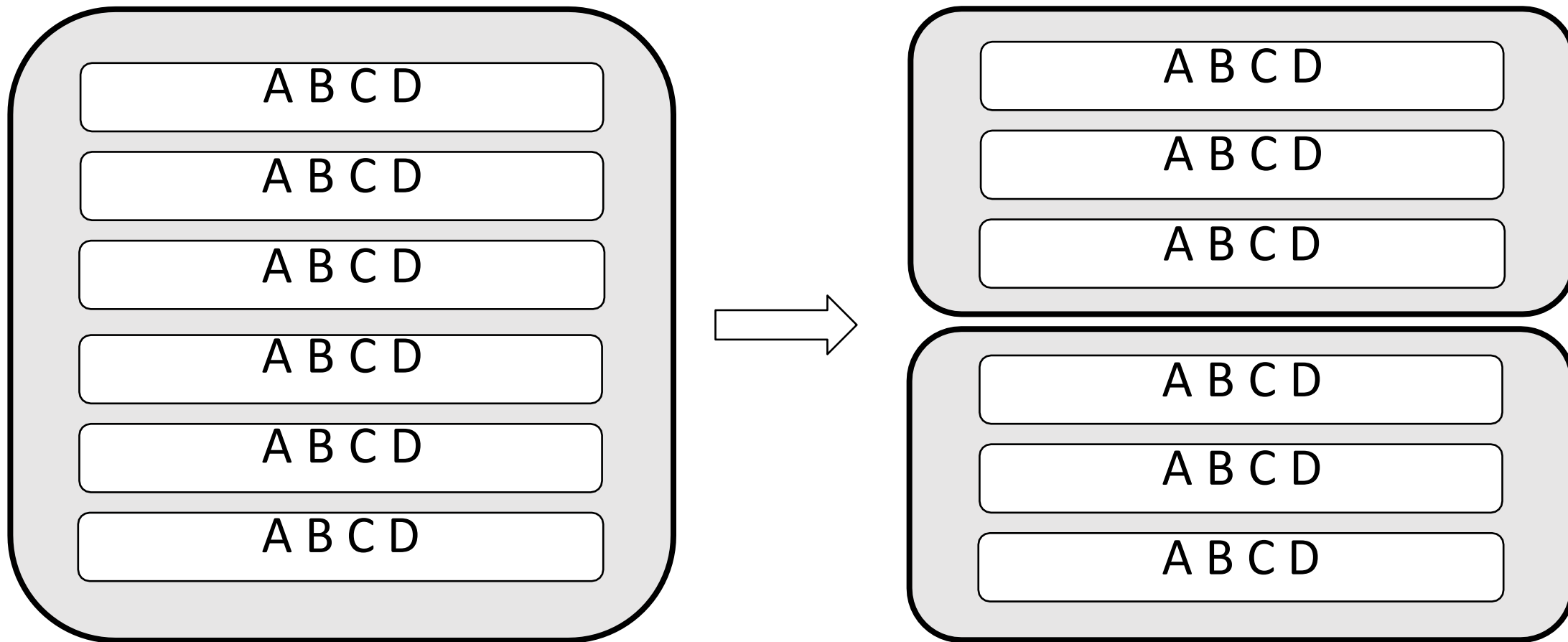

Vertical Partitioning Interferes With Horizontal Partitioning

The fact table is horizontally partitioned (on date, allows to skip lots of data)

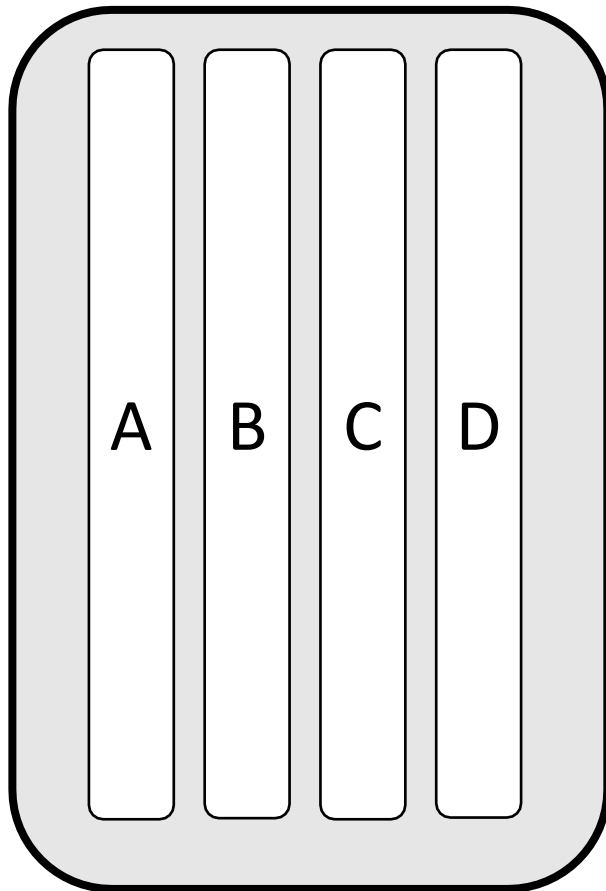

Cannot horizontally partition because the vertical partitions do not contain date info

Experimenting with row-stores (SSB averages)

tuple reconstruction (via expensive joins)
prior to the join between tables

tuple overheads (additional record IDs)

+ could not horizontally partition + more expensive hash joins

```
select sum(lo_revenue), d_year, p_brand1
from lineorder, date, part, supplier
where lo_orderdate = d_datekey and
       lo_partkey = p_partkey and
       lo_suppkey = s_suppkey and
       p_category = 'MFGR#12' and
       s_region = 'AMERICA'
group by d_year, p_brand1
order by d_year, p_brand1;
```

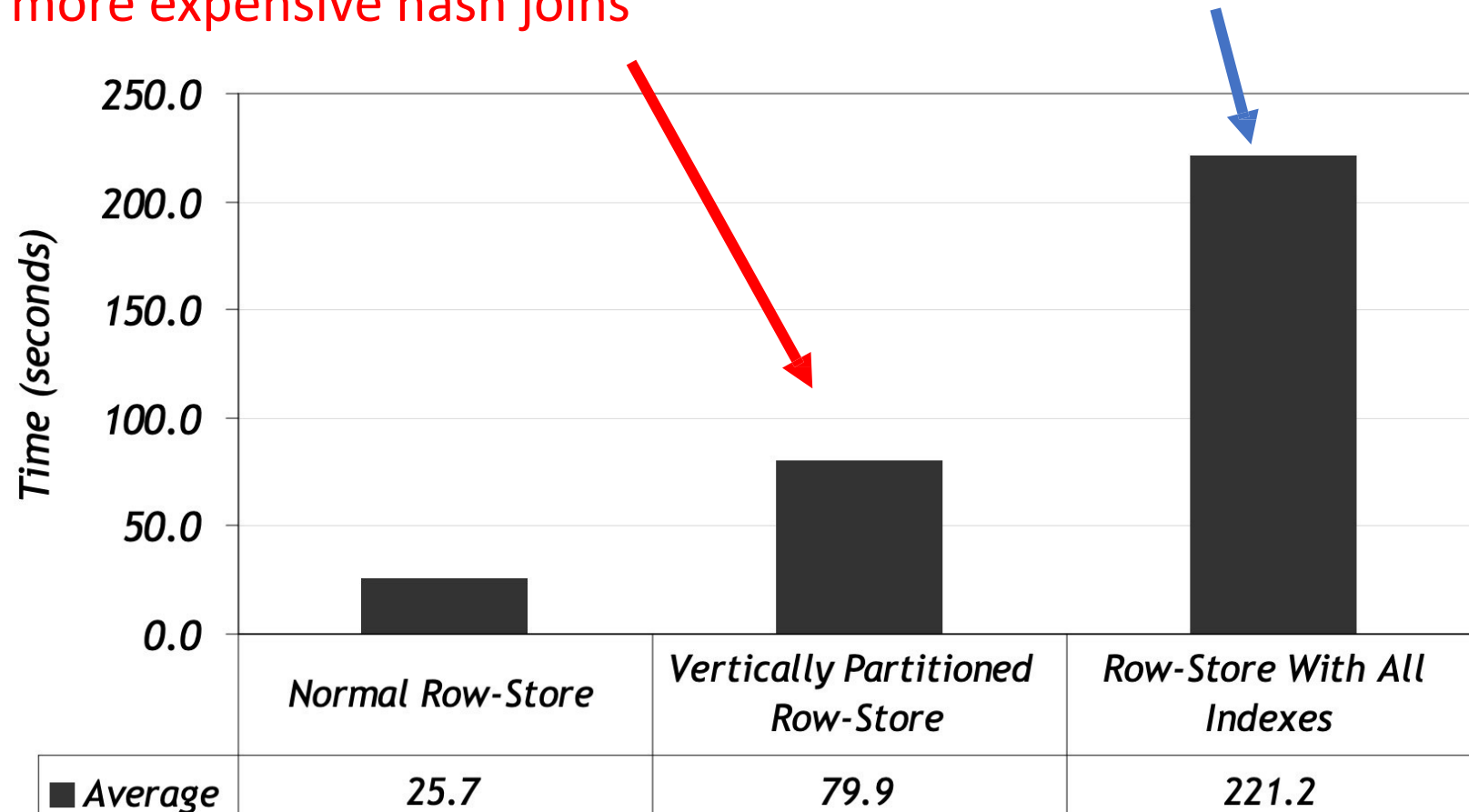

Details on All Indexes

A common query pattern:

```
SELECT store_name, SUM(revenue)
FROM Facts, Stores
WHERE fact.store_id = stores.store_id AND
        stores.country = "Canada"
GROUP BY store_name
```

All qualifying tuples (based on where clause) are selected and reconstructed (“stitched together”)

Note that indexes map to TIDs, and then from TIDs we get the column’s value

Tuple reconstruction is SLOW!

Can we simulate a column-store with a row-store?

(a) All Indexes is a poor way to do it



(b) Vertical Partitioning's problem are NOT fundamental

- i. tuple header can be removed*
- ii. TIDs can be virtual*
- iii. horizontal partitioning can be based on the values of a different VP*

But still, column-stores and row-stores are apples and oranges!!

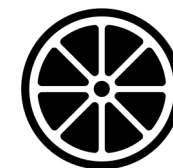

Row-Stores vs. Column-Stores (SSB average)

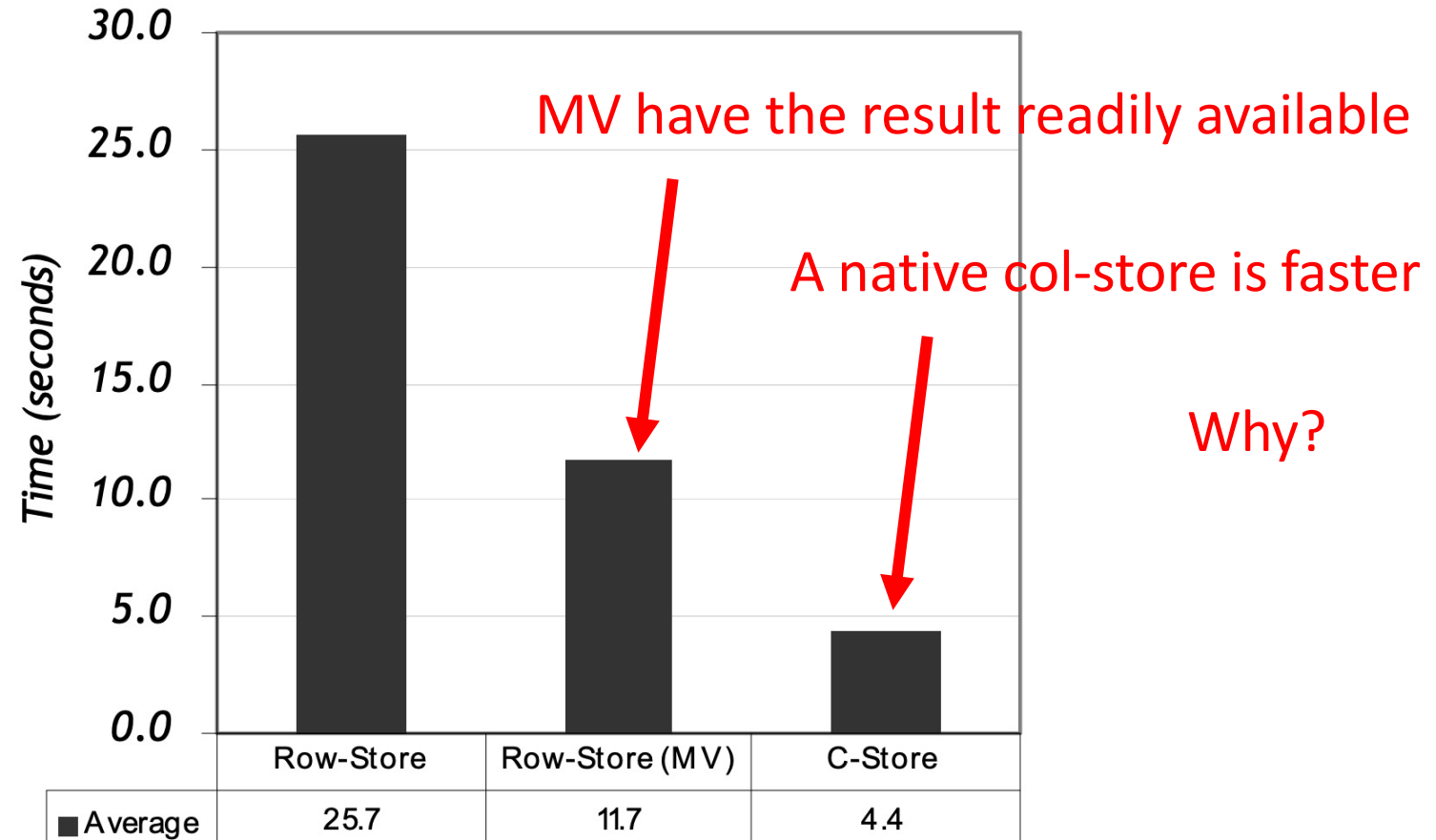

Methodology

Start from a native column-store

Remove column-store-specific performance optimizations

End with a column-store with a row-oriented query engine

A. Compression

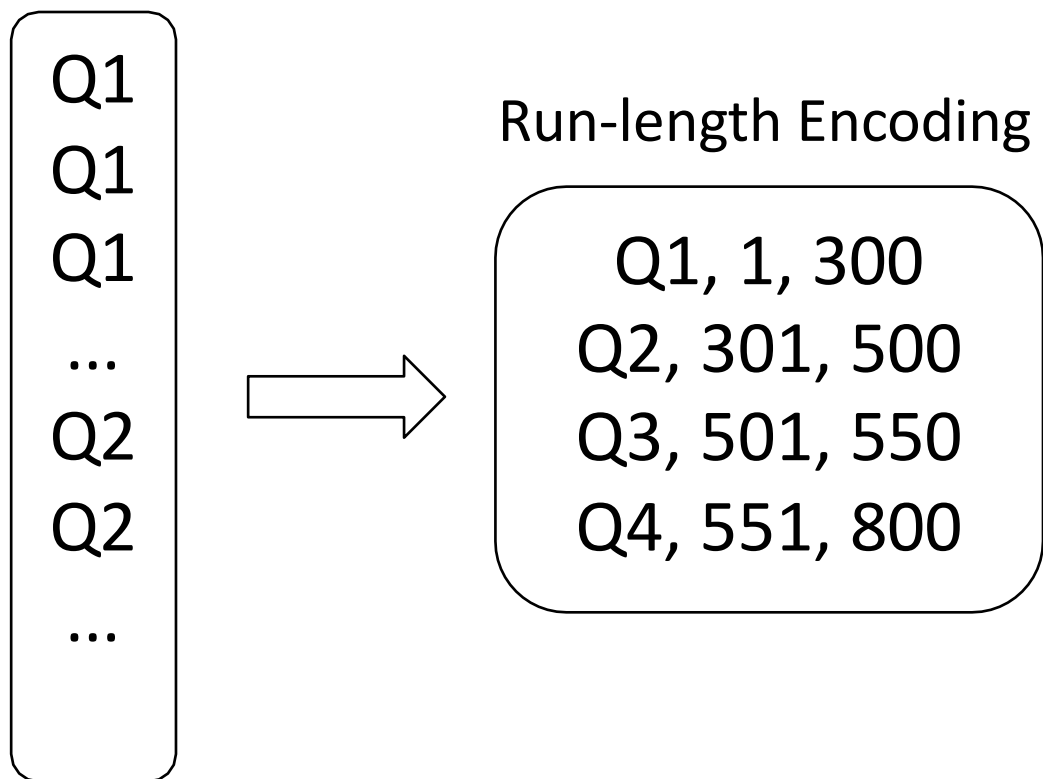

Alternative: Dictionary Compression

- ▶ Replace variable size with minimal fixed length e.g., integer



Benefits of col-store compression

Reduces I/O

Can operate directly on compressed data

How?



Are the same benefits applicable for row-store compression?

Reduces I/O → yes, but with lower ratio (less data value locality)

No! Requires decompression before processing



B. Early vs. Late Materialization

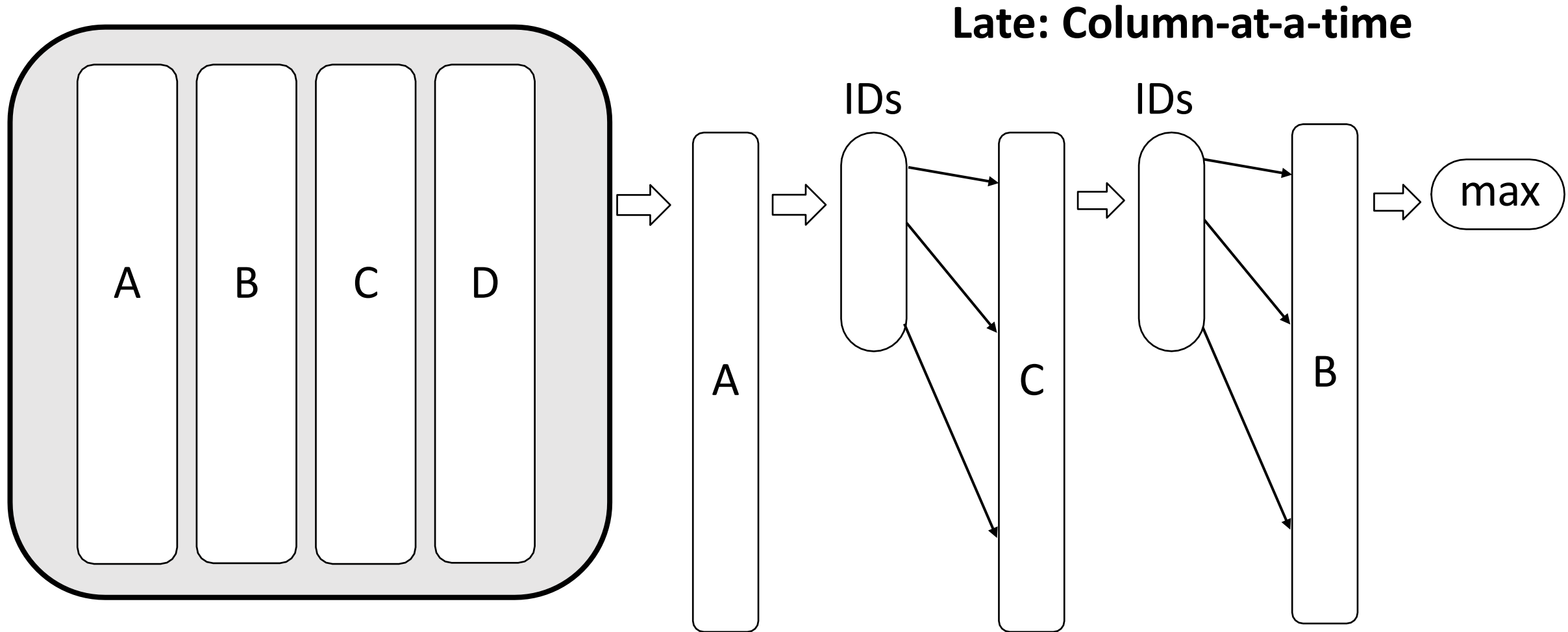

B. Early vs. Late Materialization

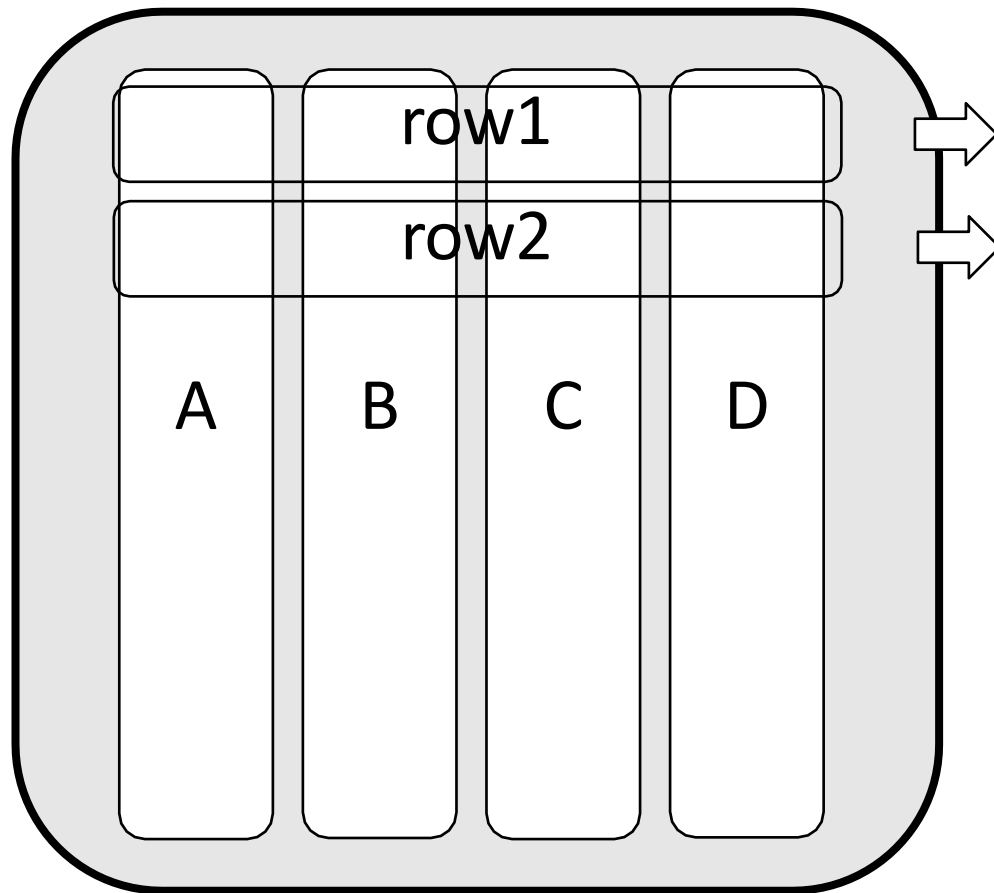

Early: Row-at-a-time

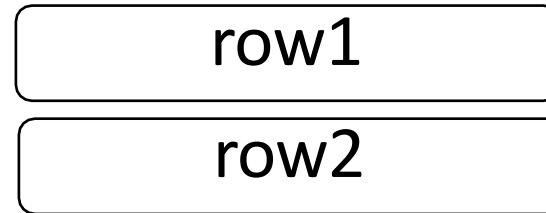

At what cost?

Poor memory bandwidth utilization

Lose opportunity for vectorized execution

C. Block Iteration

select max(B) from R where A>5 and C<10

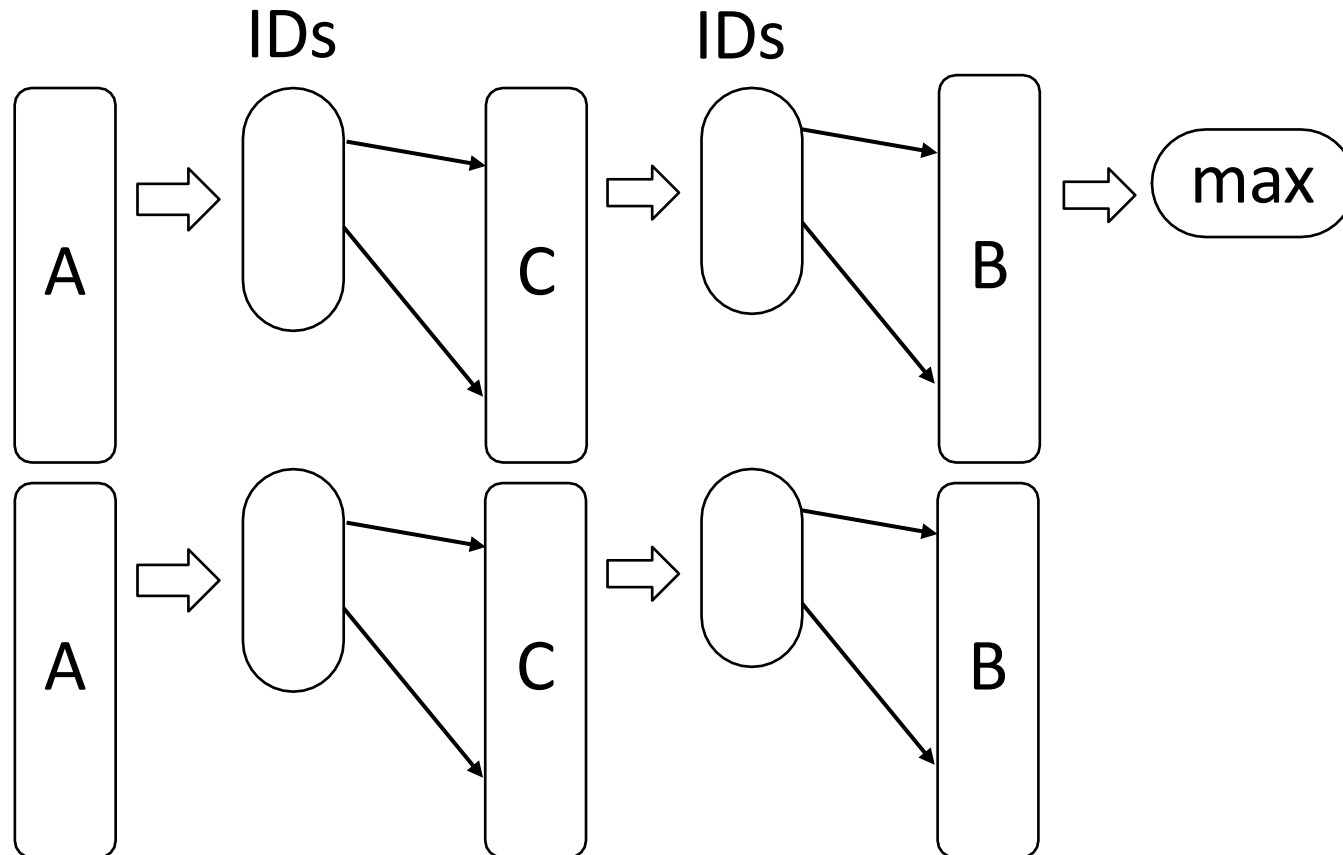

whole column?

column at a time

block/vector at a time

D. Invisible Joins

Idea: rewrite joins as predicates on foreign keys in fact table

Algorithm:

1. apply each predicate to the appropriate dimension table
2. build a hash table on matching keys
3. compute bitvector with bits set for qualifying positions (tuples)
4. intersect bitvectors (positions) via bitwise AND
5. for each resulting position reconstruct the resulting tuple

1. apply each predicate to the appropriate dimension table
2. build a hash table on matching keys

Apply region = 'Asia' on Customer table

custkey	region	nation	...
1	Asia	China	...
2	Europe	France	...
3	Asia	India	...

Hash table
with keys
1 and 3

Apply region = 'Asia' on Supplier table

suppkey	region	nation	...
1	Asia	Russia	...
2	Europe	Spain	...

Hash table
with key 1

Apply year in [1992,1997] on Date table

dateid	year	...
01011997	1997	...
01021997	1997	...
01031997	1997	...

Hash table with
keys 01011997,
01021997, and
01031997

```

SELECT c.nation, s.nation, d.year,
       sum(lo.revenue) as revenue
FROM customer AS c, lineorder AS lo,
     supplier AS s, dwdate AS d
WHERE lo.custkey = c.custkey AND
      lo.suppkey = s.suppkey AND
      lo.orderdate = d.datekey AND
      c.region = 'ASIA' AND s.region = 'ASIA' AND
      d.year >= 1992 and d.year <= 1997
GROUP BY c.nation, s.nation, d.year
ORDER BY d.year asc, revenue desc;

```

3. compute bitvector with bits set for qualifying positions (tuples)
4. intersect bitvectors (positions) via bitwise AND

Fact Table

orderkey	custkey	suppkey	orderdate	revenue
1	3	1	01011997	43256
2	3	2	01011997	33333
3	2	1	01021997	12121
4	1	1	01021997	23233
5	2	2	01021997	45456
6	1	2	01031997	43251
7	3	2	01031997	34235

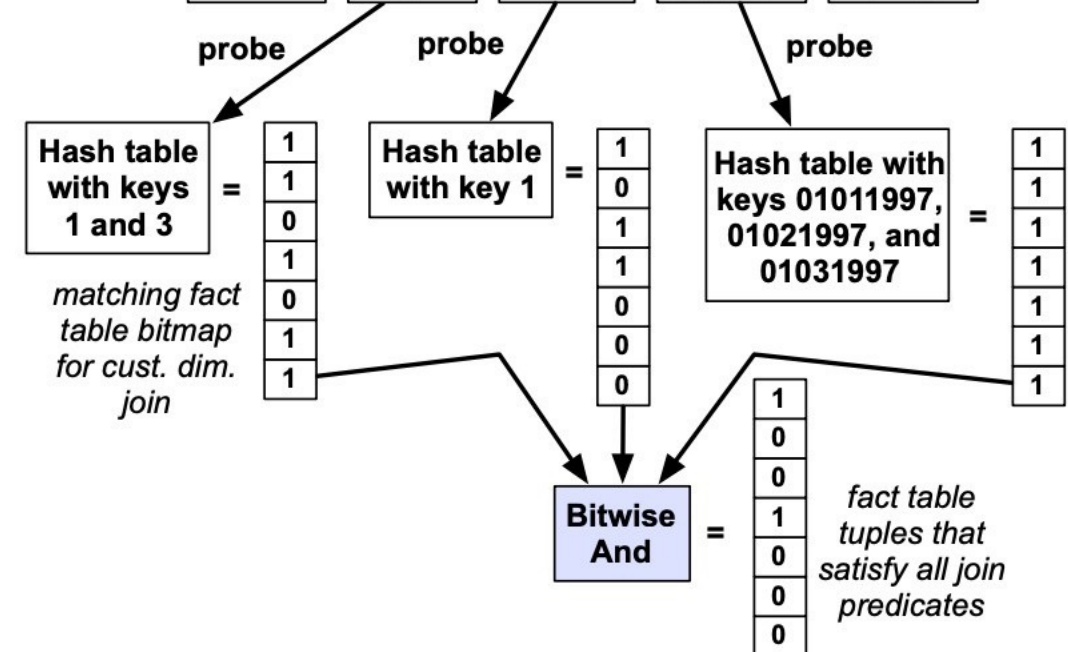

5. For each resulting position, extract the values from the columns that are in the result



Are invisible joins a general join algorithm?

No! It works only for Star Schemas

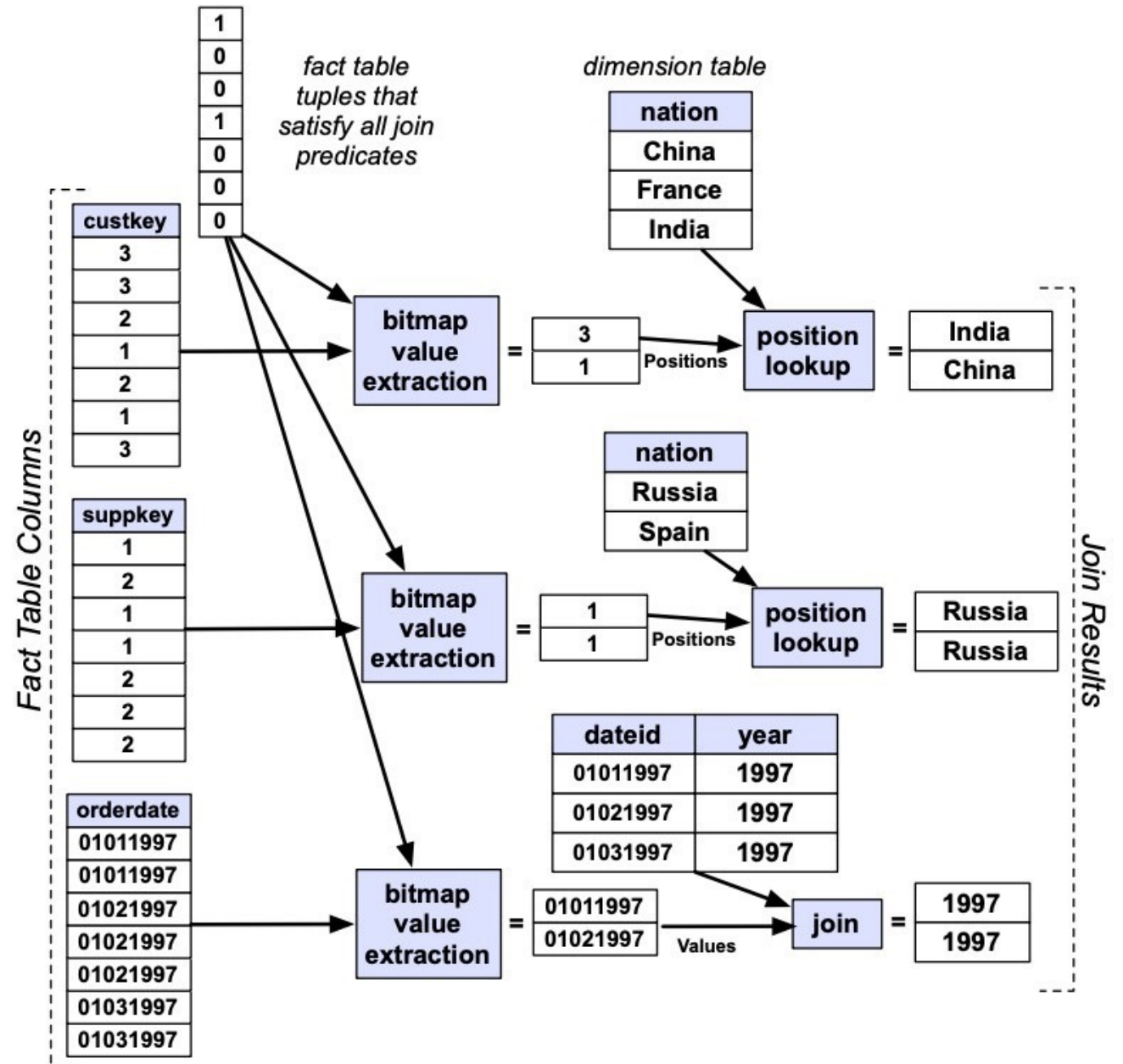

To make the most of a col-store

- 1. Efficient support of vertical partitioning (compression)
- 2. Column-specific execution (late materialization)

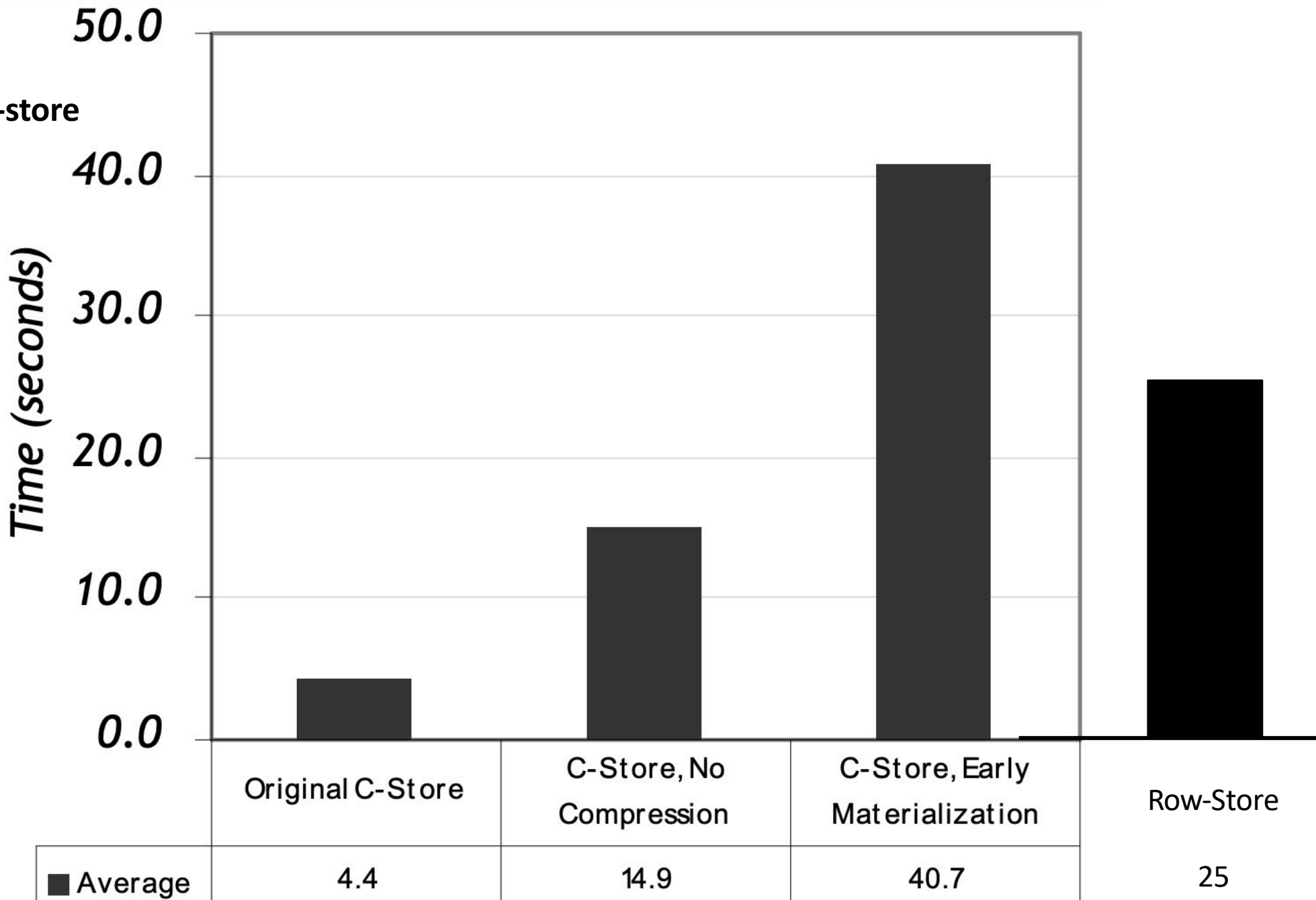

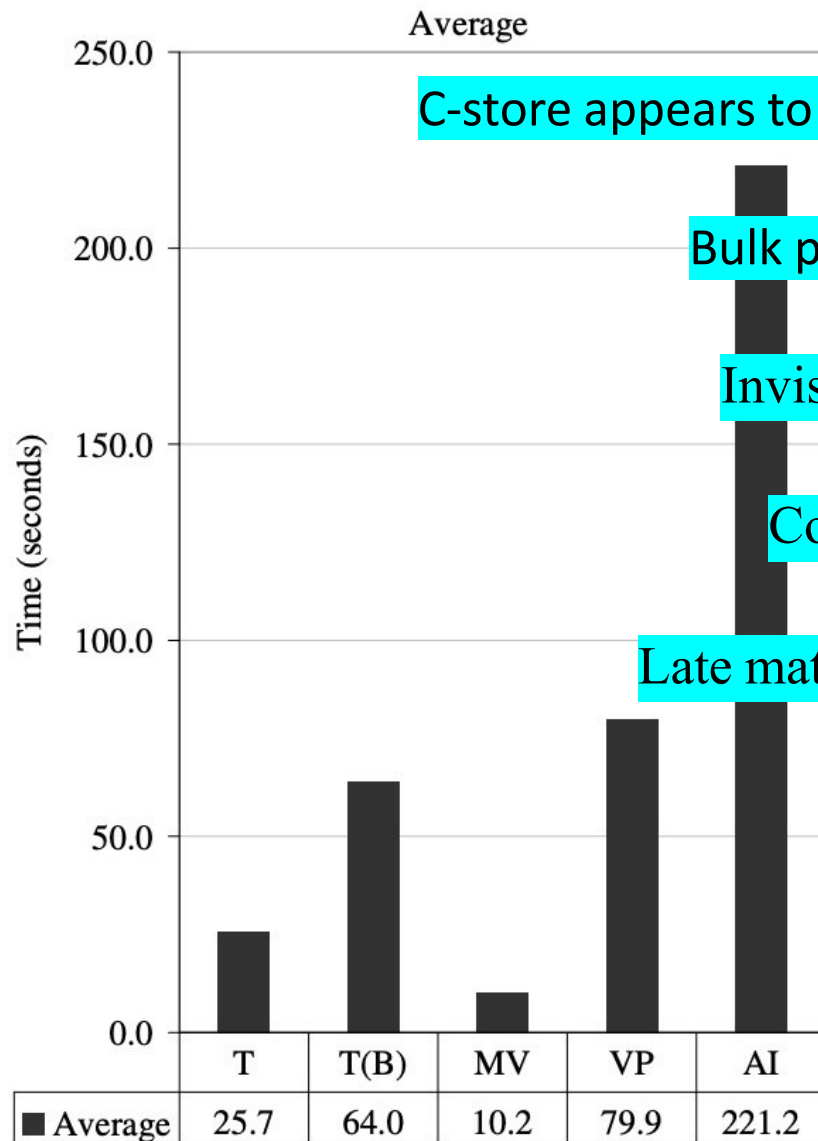

T is traditional, T(B) is traditional (bitmap),
 MV is materialized views, VP is vertical partitioning,
 and AI is all indexes

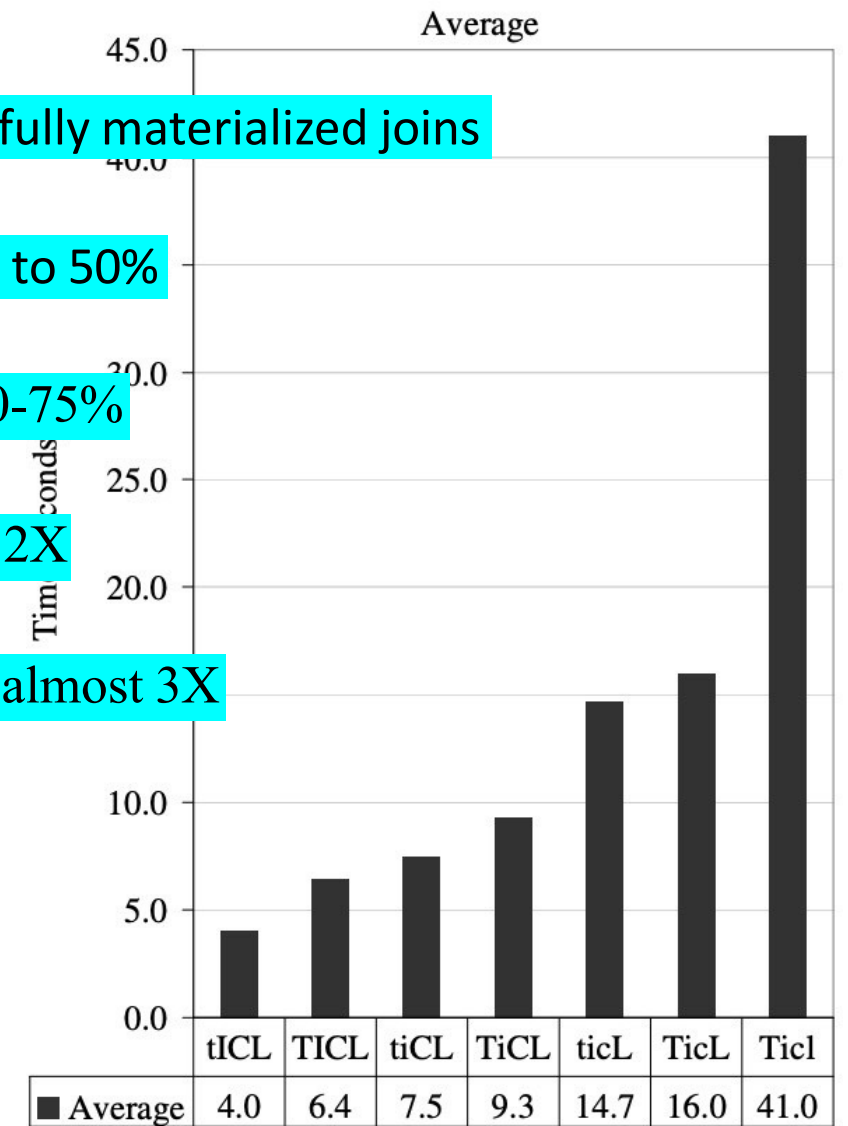

T=tuple-at-a-time processing, t=block processing;
 I=invisible join enabled, i=disabled;
 C=compression enabled, c=disabled;
 L=late materialization enabled, l=disabled

C-store appears to do even better than fully materialized joins

Bulk processing buys you 5 to 50%

Invisible join buys you 50-75%

Compression buys you 2X

Late materialization gets you almost 3X

Things to remember

Row-stores vs. Col-stores: fundamental differences

- ✓ Compression
- ✓ Late Materialization
- ✓ Block Iteration
- ✓ Column-store-specific join optimizations

